

iXon Ultra

The World's Highest Performance
Back-illuminated EMCCDs

NOW WITH
SRRF-STREAM
TECHNOLOGY

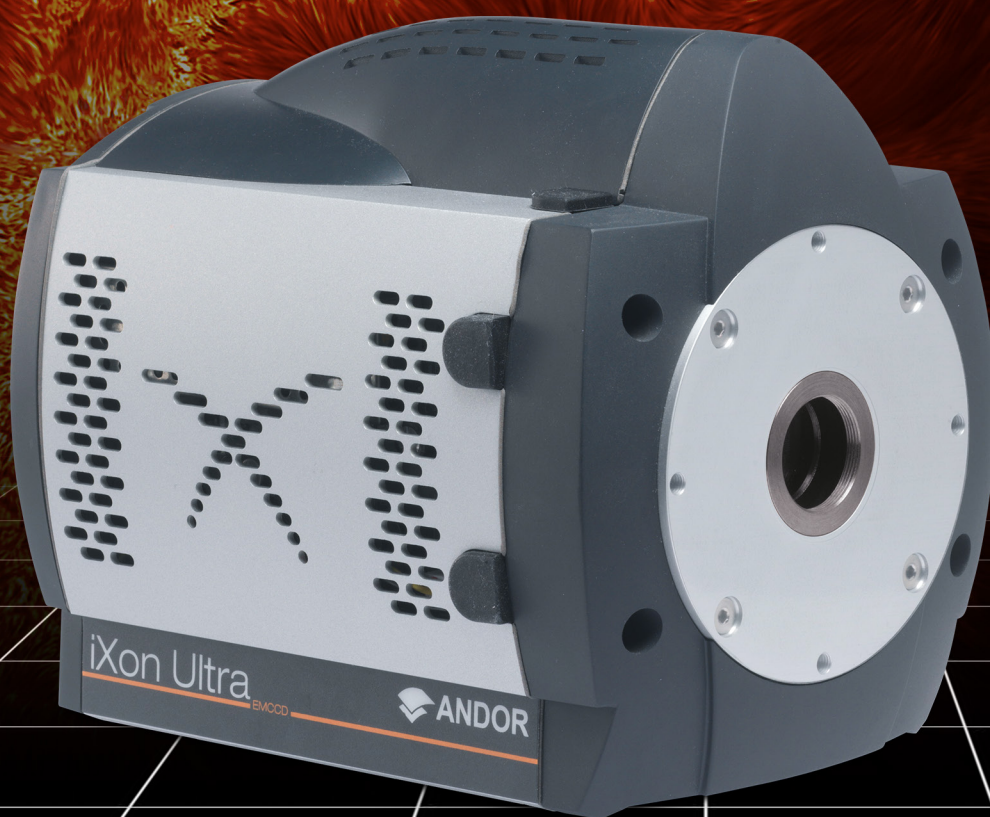

iXon Ultra 888

- Largest Field of View EMCCD
- 1024 x 1024
- 13 μm pixel size
- Single Photon Sensitive
- > 95% QE
- 26 fps full frame
- 93 fps @ 512 x 512
- TE Cooling to -95°C

iXon Ultra 897

- 512 x 512
- 16 μm pixel size
- Single Photon Sensitive
- > 95% QE
- 56 fps full frame
- TE Cooling to -100°C

iXon Ultra

iXon Ultra 888: Field of View & Sensitivity... Now 3x Faster!

The highly innovative **iXon Ultra 888** megapixel, back-illuminated EMCCD camera offers single photon sensitivity across a large field of view, at 26 fps. Building on a rich history of first to market innovation, the ‘supercharged’ iXon Ultra 888, represents a massive performance boost for the largest available EMCCD sensor, as well as the first USB 3.0 enabled EMCCD camera.

The iXon Ultra 888 has been fundamentally re-engineered to facilitate a **3x acceleration** of the pixel readout speed to an unprecedented 30 MHz, whilst maintaining quantitative stability, propelling the full frame performance to **video rate**. Furthermore, Andor’s unique ‘**Crop Mode**’ can be employed to further boost frame rates from a user defined sub-region, for example pushing a 512 x 512 sub-array to 93 fps and a 128 x 128 area to **697 fps**.

With a **1024 x 1024 sensor format and 13 µm pixel size**, the resolving power, field of view and unparalleled speed of the iXon Ultra 888 render it the most attractive and versatile EMCCD option for demanding applications such as single molecule detection, super-resolution microscopy, live cell imaging and high time resolution astronomy.

The iXon Ultra is designed to be the most **flexible** yet **easy to use** EMCCD on the market, optimizable for a wide variety of application requirements in a single click via the OptAcquire™ feature. Furthermore, signal can be quantitatively calibrated in units of **electrons** or **photons**, either in real time or post-processing. Patented, pioneering technology offers **automated recalibration** of EM gain, alongside anti-ageing protection.

Crucially, the iXon brand carries an outstanding reputation within the industry for **quality** and **reliability**, brandishing an unparalleled track record of minimal field failures.

NEW SRRF-Stream Real Time Super-Resolution

Available for both 888 and 897 models, **SRRF-Stream** camera technology converts most modern conventional microscopes into a real time super-resolution microscope, for imaging live and fixed cells with low excitation intensities and without the need for specialized photoswitchable fluorophores (e.g. works with GFP).

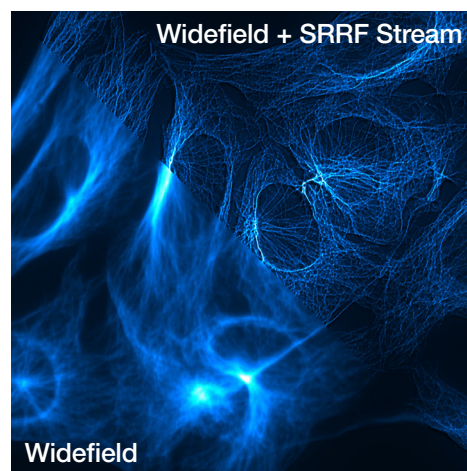
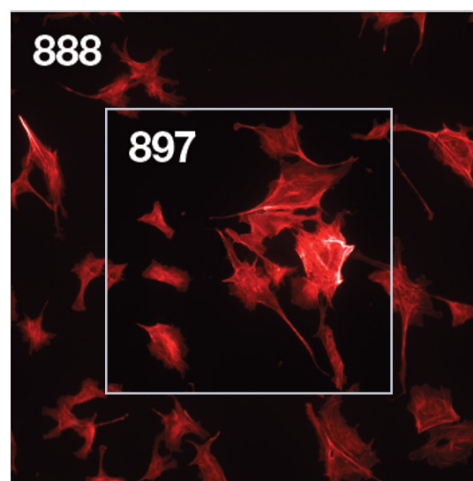

Image comparison of a fluorescently labelled fixed BPAE cell, recorded with a widefield fluorescence microscope and a SRRF-Stream enabled iXon 888 camera.

Key Specifications

Active pixels (H x V)	1024 x 1024
Pixel size (W x H; µm)	13 x 13
Image area (mm)	13.3 x 13.3
Active Area Pixel Well Depth (e ⁻)	80,000
Max Readout Rate (MHz)	30
Frame rates (fps)	26 (full frame) - 9690
Read noise (e ⁻)	<1 with EM gain
QE Max	>95%



Field of View Comparison between iXon Ultra models. The 888 model has a x2.6 greater sensitive area than the 897 model.

iXon Ultra 897: The market leading back-illuminated EMCCD, now accelerated to 56 fps.

The **iXon Ultra 897** platform takes the popular back-illuminated 512 x 512 frame transfer sensor and overclocks readout to 17 MHz, pushing speed performance to an outstanding 56 fps (full frame), whilst maintaining single photon sensitivity and quantitative stability throughout. New Optically Centred Crop Mode unlocks unparalleled frame rate performance from centrally located ROIs, ideal for the particular speed and sensitivity requirements of super-resolution microscopy.



The iXon Ultra maintains all the advanced performance attributes that have defined the industry-leading iXon range, such as deep vacuum cooling to -100°C, extremely low spurious noise, and Andor's patented EM gain recalibration technology (EMCA™). Count Convert functionality allows real time data acquisition in units of electrons or incident photons and OptAcquire facilitates one-click optimization of this versatile camera to a variety of application conditions.

Additional features of the iXon Ultra include plug and play USB connectivity, a lower noise conventional CCD mode and an additional Camera Link output, offering the unique ability to directly access data for 'on the fly' processing, ideally suited to data intensive applications such as adaptive optics or super-resolution microscopy.

Key Specifications

Active pixels (H x V)	512 x 512
Pixel size (W x H; μm)	16 x 16
Image area (mm)	8.2 x 8.2
Active Area Pixel Well Depth (e^-)	180,000
Max Readout Rate (MHz)	17
Frame rates (fps)	56 (full frame) - 11,074
Read noise (e^-)	<1 with EM gain
QE Max	>95%

Stability Plot

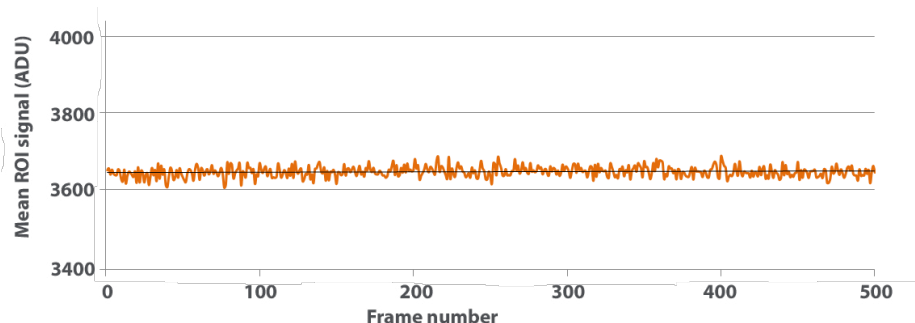

EM Gain stability in the iXon Ultra 897 @ 55 fps.
500 frame kinetic series; frame transfer (overlapped)
acquisition; 17.8 ms exposure time; x300 EM gain.

Features & Benefits

Features & Benefits of the iXon Ultra series

Single Photon Sensitive & > 95% QE	Optimal SNR in light starved applications such as single molecule detection and quantum physics.
NEW 'SRRF-Stream' (optional)	Real time, cell super-resolution functionality. Living and fixed cells, works on most modern fluorescence microscopes. Super-resolution down to 50nm.
NEW Blue optimized model	Our new sensor option offers up to 20% higher sensitivity to photons across the blue region of the spectrum, ideal for quantum and ion imaging as well as blue-emitting BEC.
Overclocked readout speeds	Follow dynamic changing processes.
Crop Mode	Continuous imaging with fastest possible frame rate from centrally positioned ROIs. Highly enabling for live cell super-resolution and much more (e.g. 251 fps with 256 x 256 ROI).
TE cooling to -100°C	Elimination of dark current detection limit.
Superior Baseline Clamp and EM Stability	Essential for quantitative accuracy of dynamic measurements.
RealGain™	Absolute EMCCD gain selectable directly from a linear and quantitative scale.
Lower Noise CCD Mode	'2 in 1' flexibility. EMCCD for ultra-sensitivity at speed, conventional CCD for longer acquisitions.
EX2 Technology	Extended QE response, beyond standard back-illuminated.
Fringe Suppression	Reduced etaloning in NIR.
OptAcquire	Optimize the highly flexible iXon for different application requirements at the click of a button.
Count Convert	Quantitatively capture and view data in electrons or incident photons. Applied either in real time or post-processing, Count Convert does this important conversion for you.
EMCAL™	Patented user-initiated self-recalibration of EM gain.
iCam	Exposure time fast switching provides market leading acquisition efficiency.
Minimal Clock-Induced Charge	Unique pixel clocking parameters, yielding minimized spurious noise floor.
UltraVac™	Critical for sustained vacuum integrity and to maintain unequalled cooling and QE performance, year after year. Seven year vacuum warranty.
Spurious Noise Filter	Intelligent algorithms to filter clock induced charge events from the background. Real-time or post-processing.
Direct Data Access (Ultra only)	Camera Link output port to facilitate direct access to data for 'on the fly' processing.
Enhanced photon counting modes	Intuitive single photon counting modes to overcome multiplicative noise. Real time or post-processing.
FPGA Timestamp	Hardware generated timestamp with 10 ns accuracy.
ASTRO.control compatibility (Ultra only)	Redlogix ASTRO.control is a dedicated platform for control of astronomical telescopes and instrumentation http://www.andor.com/astrocontrol.aspx

Application Focus

The Physicist's Choice

The unique high-performance specifications of the optimized iXon range have been serving the physical scientist and astronomer in scenarios that demand more than simply an EM sensor in a camera. Andor have worked with numerous scientists to deliver solutions that work for their particular application requirements, such as specific coatings, coupling to fibre optic scintillators and 'minimized latency' direct data access solutions.

Application Examples

Quantum Science

Quantum entanglement is now being studied with the aim of providing insight into the practical applications of this phenomenon. Quantum cryptography, communication and computing may soon rely on high-fidelity readouts of entangled photons. To detect these single particles researchers must rely on the most sensitive detection as is provided by iXon Ultra EMCCD cameras.

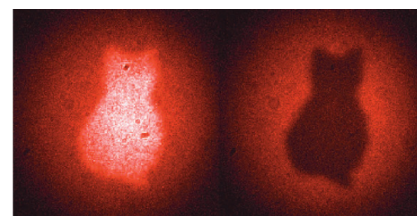

Quantum entanglement, see [Quantum imaging finally saves Schrödinger's cat](#). Courtesy of Anton Zeilinger, Institute for Quantum Optics and Quantum Information, University of Vienna.

Cold Atom & Ion Research

Our new blue-enhanced back-illuminated EMCCD sensor option is ideal for cold atom imaging experiments such as blue-emitting Bose-Einstein Condensation (BEC), ion traps and degenerate matter studies. Single photon sensitivity enables users to discern signals from single trapped ions and atoms.

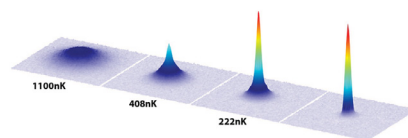

A phase transition and BEC formation in a gas of erbium atoms imaged at 401 nm matched by camera's QE at approx. 75%. Courtesy of K. Aikawa et al., University of Innsbruck, Austria.

Fast Astronomy

Extremely fast and ultra-sensitive performance of binned sub-regions make the iXon Ultra an ideal Shack Hartmann AO detector. The large FOV of the Ultra 888 and fast frame rate are ideal for Lucky / Speckle Imaging.



The iXon Ultra 888 serves as the Focal Plane Imager of the SOFIA telescope. Courtesy of Pasquale Temi & E.E. Becklin, NASA.

Tomography

Lens coupled or customer fibre coupled, the iXon Ultra provides the superlative ultrasensitive, large array solution for fast tomography.

Fast Spectroscopy

The iXon Ultra has been a very valuable detector for fast spectroscopy applications, such for rapid spectroscopic mapping or fast monitoring of fast chemical reactions. When operated in full vertical binning the cameras can be pushed to thousands of spectra per second, accessing sub-ms dynamics. The iXon Ultra camera models are fully compatible with Andor's Kymera and Shamrock range of high-end spectrographs.

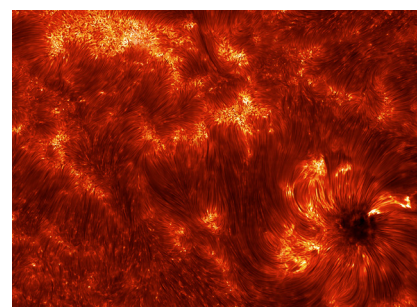

Magnetic fibrils that weave through the solar chromosphere. Courtesy of Kevin Reardon, National Solar Observatory.

iXon Ultra 888 – Capture everything, large or small, fast or slow...

Extreme Sensitivity – capture, resolve and quantify extremely weak structures.

Capture More – the 13.3 x 13.3 mm sensor of the Ultra 888 is well suited to the optically useful FOV from a microscope.

3x Faster – more and more studies of cell processes require greater temporal resolution. The Ultra 888 offers the fastest available EMCCD readout capability.

Superb Image Quality – megapixel resolution and uniform backgrounds for publication quality imaging.

2 in 1 – the Ultra 888 can operate as an EMCCD or a low noise CCD, rendering it optimal for both fast and slow capture.

Application Focus

The Biologist's Choice

In applications such as single molecule microscopy, super-resolution, live cell microscopy (including confocal), calcium signalling, transport/motile imaging and intracellular bioluminescence, weak, rapidly changing fluorescent signals from cells must be dynamically imaged. Andor's iXon technology offers an ideal detection solution. Ultra-sensitive detection capability in fluorescence microscopy facilitates use of lower excitation powers (thereby reducing photobleaching and phototoxicity) and lower dye concentrations.

Application Examples

Single Molecule Detection

Andor's iXon EMCCD has long been the gold standard detector of the biophysics laboratory, and remains the dominant detector type, operating in a low light regime that is less suited to sCMOS cameras. The 3x accelerated 30 MHz readout speed of the iXon Ultra 888, especially combined with 'Optically Centred Crop Mode', means that dynamic single molecule processes can be better characterized. The 13 μm pixel provides superb resolving capability at the diffraction limit.

SRRF-Stream

The iXon has proven extremely popular for single molecule based 'pointillist' super-resolution microscopy approaches (e.g. STORM, PALM). **SRRF-Stream** is a **NEW real time super-resolution** 'nanoscopy' functionality that operates on Andor's iXon EMCCD cameras. 'SRRF-Stream unlocks the means to perform real time super resolution microscopy on **conventional modern fluorescence microscopes**. Resolution improvement from **2- to 6-fold (50-150 nm final resolution)** can be expected for most datasets.

Spinning disk confocal

The iXon Ultra 888 is the ultimate detector to drive stunning performance from confocal spinning disk technology. Whilst affording superb confocality and low rates of phototoxicity, spinning disk experiments are inherently photon starved, by virtue of the photon rejection implicit to optical sectioning.

The superior sensitivity of the iXon Ultra detector brings these low light images to life.

Luminescence

The iXon Ultra can be used in either single photon counting mode (EM amplifier) or in slow scan, deep cooled CCD mode (CCD amplifier) as a highly sensitive and flexible detector in this typically long exposure, extreme low light application.

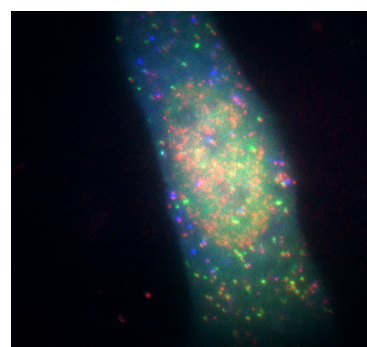

Single molecule imaging mRNA (red), during translation, and proteins, FLAG-KDM5B (green) and HA-KDM5B (blue). *Courtesy of Timothy J. Stasevich, IGAf, Colorado State University.*

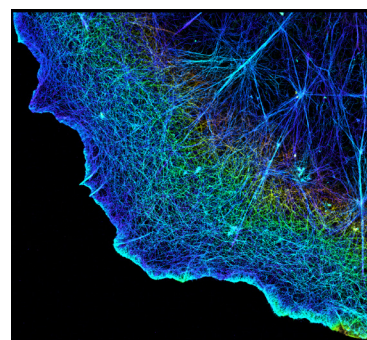

3D STORM image of actin cytoskeleton (AF647-phalloidin) in COS-7 cell. Colour codes for z-depth. *Image courtesy of Xiaowei Zhuang, Harvard University.*

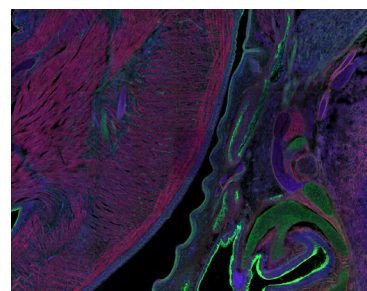

Spinning disk confocal image (right) of a mouse embryo section with F-actin (AF568-phalloidin), membrane glycoproteins (AF488-WGA), and DNA (DAPI) labelling.

EMCCD or sCMOS?

Since the introduction of sCMOS technology by Andor, the question of the performance comparison against the more established Electron Multiplying CCD (EMCCD) has been a common one.

Being a very fast, low noise technology, sCMOS does hold some potential to offer an alternative technology across some applications and techniques, including to an extent, TIRF microscopy. Whilst the read noise of sCMOS is very low compared to CCDs, EMCCD technology holds the distinct advantage of being able to practically eliminate read noise, rendering them single photon sensitive.

“...EMCCDs offer a raw sensitivity that cannot be surpassed in the very low light regime”.

After a few years of sCMOS being tested in the market, we are concluding that the primary light staved applications for which EMCCDs were originally purchased, such as single molecule detection and low light spinning disk confocal microscopy, are continuing to strongly benefit from this ultrasensitive technology. EMCCDs offer a raw sensitivity that cannot be surpassed in the very low light regime.

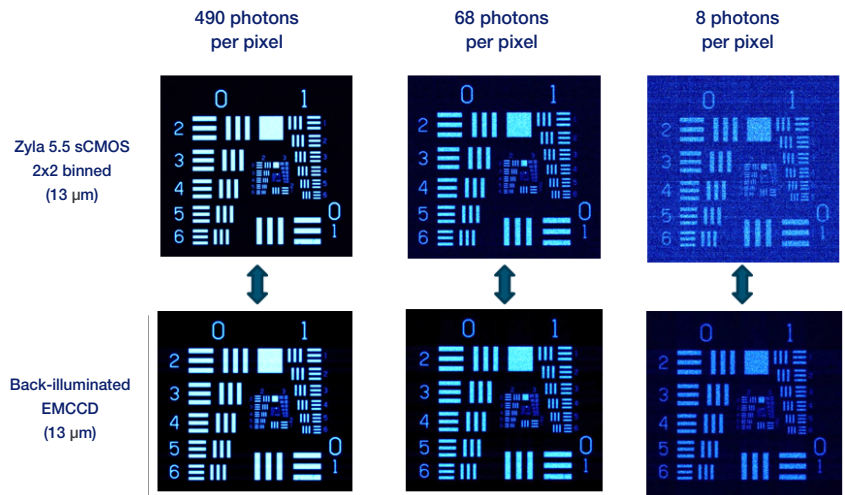

Images at a range of incident light intensity, acquired using back-illuminated EMCCD iXon 888 and Zyla 5.5 sCMOS cameras (2x2 binned pixels). At low light intensities, the Signal to Noise Ratio advantage of the EMCCD is apparent (in this example the 8 photons per pixel images).

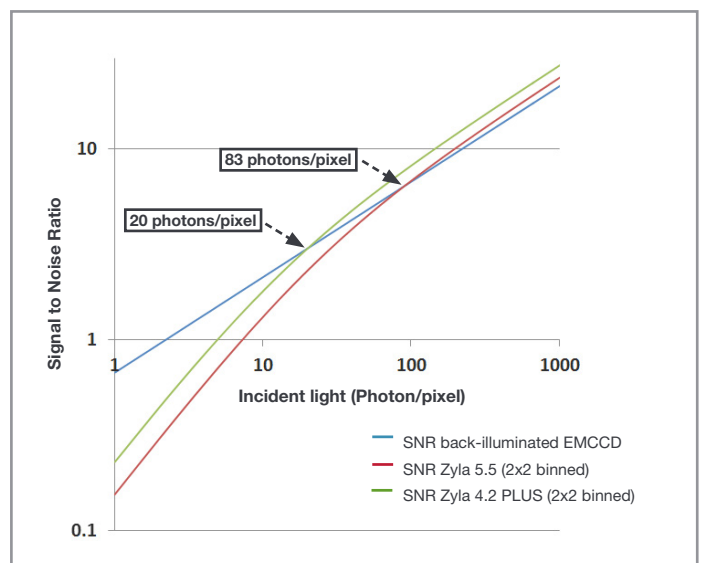

Plot of Signal to Noise Ratio versus Incident Photon Intensity, comparing a back-illuminated EMCCD iXon 888 (13 μm pixel size) to 2x2 binned Zyla sCMOS cameras (13 μm pixel size after binning)

Input Parameters

- Average QE of each sensor between 500 – 750 nm
- rms read noise values
- Fast sCMOS readout (minimum distortion and maximum frame rate)
- sCMOS 2x2 binned to yield equal pixel size to EMCCD

Technical Specifications

System Specifications ^{*2}

	Ultra 888		Ultra 897	
Sensor QE options	#BV: Back Illuminated, standard AR coated BVF: Back Illuminated, standard AR coated with fringe suppression UVB: Back Illuminated, standard AR with additional lumogen coating #EX: Back illuminated, dual AR coated EXF: Back illuminated, dual AR coated with fringe suppression NEW #BB: Back-illuminated, blue optimized AR coated			
Fringe Suppression	Available on EXF and BVF sensor options			
Active pixels	1024 x 1024		512 x 512	
Pixel size	13 x 13 μm		16 x 16 μm	
Image area	13.3 x 13.3 mm with 100% fill factor		8.2 x 8.2 mm with 100% fill factor	
Pixel Readout Rate	10 MHz	30 MHz ^{*3}	10 MHz	17 MHz
Minimum temperature, air cooled, ambient 20°C Chiller liquid cooling, coolant @ 10°C, >0.75l/min	-80°C -95°C	-60°C -75°C	-80°C -100°C	-80°C -100°C
Thermostatic Precision	$\pm 0.01^\circ\text{C}$			
Triggering	Internal, External, External Start, External Exposure, Software Trigger			
System window type	#BV and BVF: UV-grade fused silica, Broadband Visible-Near Infrared, 0.5 degree wedge UVB, #EX, EXF: UV-grade fused silica, Broadband Vacuum Ultraviolet-Near Infrared, 0.5 degree wedge iXon Blue: UV-grade fused silica, Broadband Vacuum Ultraviolet-Near Infrared, 0.5 degree wedge			
Blemish specification	Grade 1 sensor from supplier. Camera blemishes as defined by Andor Grade A https://andor.oxinst.com/learning/view/article/ccd-blemishes-and-non-uniformities			
Digitization	16-bit (at all speeds)			
PC Interface	USB 3.0 ^{*12}		USB 2.0	
Lens Mount	C-mount			
Direct Data Access	Camera Link 3-tap output			

Advanced Performance Specifications ^{*2}

	Ultra 888						Ultra 897						
Dark current and background events ^{*4,5}													
Dark current (e ⁻ /pixel/sec) @ -80°C	0.00025						0.00030						
Dark current (e ⁻ /pixel/sec) @ max cooling	0.00011						0.00015						
Spurious background (events/pix) @ 1000x gain / -85°C	0.005						0.0018						
Active area pixel well depth	80,000 e ⁻						180,000 e ⁻						
Gain register pixel well depth ^{*7,6}	730,000 e ⁻						800,000 e ⁻						
Pixel readout rates	EM Amplifier: 30, 20, 10 & 1 MHz Conventional Amplifier: 1 & 0.1 MHz						EM Amplifier: 17, 10, 5 & 1 MHz Conventional Amplifier: 3, 1 & 0.08 MHz						
Read noise (e ⁻) ^{*7}	EMCCD Amplifier			Conventional Amplifier			EMCCD Amplifier			Conventional Amplifier			
MHz	30	20	10	1	1	0.1	17	10	5	1	3	1	0.08
Without Electron Multiplication	130	80	40	12	6	3.5	89	65	37	15	9.6	5.3	2.7
With Electron Multiplication	< 1	< 1	< 1	< 1	-	-	< 1	< 1	< 1	< 1	-	-	-
Linear absolute Electron Multiplier gain	1 - 1000 times via RealGain™ (calibration stable at all cooling temperatures)												
Linearity ^{*8}	Better than 99.9%												
Vertical clock speed	0.6 to 4.33 μs (user selectable)						0.3 to 3.33 μs (user selectable)						
Timestamp accuracy	10 ns												
NEW SRRF-Stream mode	Optional												

iXon Ultra 888 Frame Rates

Standard Mode ^{*3,9}

Binning	1024 x 1024	512 x 512	256 x 256	128 x 128	1024 x 100	1024 x 32	1024 x 1
1 x 1	26	50	95	171	220	498	1163
2 x 2	50	94	170	285	368	699	-
4 x 4	92	167	281	426	552	870	-

Crop Mode - Optically Centred frame rates in brackets ^{*3,9}

Binning	512 x 512	256 x 256	128 x 128	64 x 64	1024 x 100	1024 x 32	1024 x 1
1 x 1	93 (78)	190 (251)	670 (697)	2053 (1319)	259	778	9690
2 x 2	170 (143)	350 (426)	1150 (1019)	3123 (1646)	492	1416	-
4 x 4	291 (245)	601 (653)	1772 (1504)	4109 (1857)	887	2370	-

iXon Ultra 897 Frame Rates

Standard Mode ^{*10}

Binning	512 x 512	256 x 256	128 x 128	64 x 64	512 x 100	512 x 32	512 x 1
1 x 1	56	110	212	398	267	708	2,881
2 x 2	109	210	394	699	486	1,141	-
4 x 4	206	385	682	1,109	820	1,615	-

Crop Mode - Optically Centred frame rates in brackets ^{*10}

Binning	256 x 256	128 x 128	64 x 64	32 x 32	512 x 100	512 x 32	512 x 1
1 x 1	111 (174)	595 (569)	1,433 (1,490)	3,533 (3,021)	282	857	11,074
2 x 2	215 (329)	1,094 (1,013)	2,481 (2,325)	5,555 (4,048)	541	1,607	-
4 x 4	405 (593)	1,883 (1,661)	3,906 (3,236)	7,751 (4,878)	1,005	2,865	-

Quantum Efficiency (QE) Curves ^{*11}

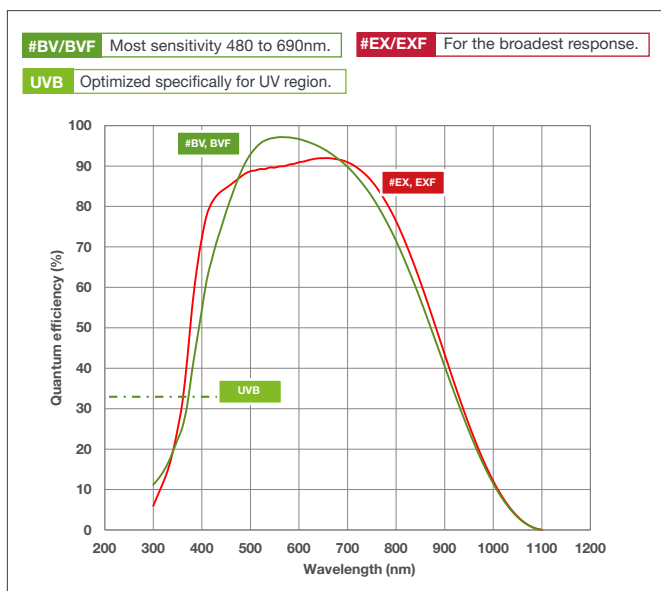

NEW Blue-optimized sensor option for quantum and BEC studies

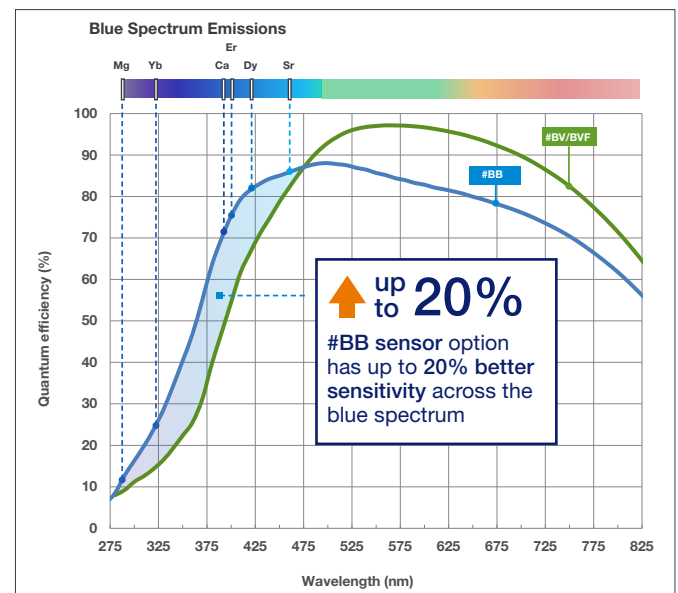

Creating The Optimum Product for You

Step 1. Choose the camera type



Camera Type

Description	Code
iXon Ultra 888: 1024 x 1024 EMCCD, max. 30 MHz, with USB 3.0	DU-888U3-CS0-
iXon Ultra 897: 512 x 512 EMCCD, max. 17 MHz, with USB 2.0	DU-897U-CS0-

Add sensor type code to camera code (see step 2)

NOTE: If SRRF-Stream real time super-resolution functionality is required with your iXon Ultra, please order as an 'accessory' in step 4 below.

Step 2. Choose the sensor type option



Sensor Type

Description	Code	Description	Code
Back-illuminated, standard AR coated	#BV	Back-illuminated, EX2 dual AR coated	#EX
Back-illuminated, standard AR coated with fringe suppression	BVF	Back-illuminated, EX2 dual AR coated with fringe suppression	EXF
Back Illuminated, standard AR with additional lumogen coating	UVB	NEW Back-illuminated, blue optimized AR coated	#BB

Add sensor type code to camera code (step 1)

Step 3. Select an alternative camera window (optional)



Camera Window

The standard window has been selected to satisfy most applications. However, other options are available. The alternative camera window code must be specified at time of ordering.

To view and select other window options please refer to the '[Camera Windows Supplementary Specification Sheet](#)' which gives the transmission characteristics, product codes and procedure for entering the order. Further detailed information on the windows can be found in the Technical note – '[Camera Windows: Optimizing for Different Spectral Regions](#)'.

Step 4. Select the required accessories



Accessories

Description	Order Code	Description	Order Code
NEW SRRF-Stream real time super-resolution functionality, compatible with iXon Ultra and iXon Life EMCCD platforms. Camera must be connected to acquisition PC workstation containing an NVidia GPU card (compute capability v3.0, or above, and 4GB or greater on-board GPU RAM).	SRRF-STREAM-CAM	Re-circulator for enhanced cooling performance	XW-RECR
NEW SRRF-Stream Dell Workstation (English), pre-installed with a recommended and tested GPU card, alongside SRRF-Stream enabled MicroManager and Andor SDK2 with SRRF-Stream.	WKST-SRRF-9ZY	Oasis 160 Ultra compact chiller unit (tubing to be ordered separately)	ACC-XW-CHIL-160
Monitor (optional) - Dell UltraSharp U3417W - 34.14" Curved LED	FUS-MNTR-34W	6 mm tubing options for ACC-XW-CHIL-160 (2x2.5 m or 2x5m lengths)	ACC-6MM-TUBING-2X2.5/ ACC-6MM-TUBING-2X5M
Dell UltraSharp UP3017 - 30" with PremierColor	FUS-MNTR-30	C-mount to Nikon F-mount adapter	OA-CNAF
OptoMask accessory, used to mask unwanted sensor area during Crop Mode acquisition (refer to OptoMask Specification Sheet for further information).	OPTMSK-L/ OPTMSK-OC-L/ OPTMSK-OC-S	C-mount to Olympus adapter	OA-COFM
		C-mount to T-mount adapter	OA-CTOT
		15 m Active USB 3.0 connector cable (power supply not required) Icron for Ultra 888	ACC-ASE-06887
		50 m Fibre Optic USB 3.0 extender solution inc. power supply (Adnaco) for Ultra 888	ACC-ASE-08762
		100 m Fibre Optic USB 3.0 extender solution inc. power supply (Adnaco) for Ultra 888	ACC-ASE-07860

Step 5. Select the required software



Software

The iXon Ultra series requires one of the following software options:

Solis Imaging A 32-bit and fully 64-bit enabled application for Windows (8, 8.1 and 10) offering rich functionality for data acquisition and processing. AndorBasic provides macro language control of data acquisition, processing, display and export.

Andor SDK A software development kit that allows you to control the Andor range of cameras from your own application. Available as 32 and 64-bit libraries for Windows (8, 8.1 and 10), compatible with C/C++, C#, Delphi, VB.NET, LabVIEW and Matlab. Linux SDK compatible with C/C++.

Andor iQ A comprehensive multi-dimensional imaging software package. Offers tight synchronization of EMCCD with a comprehensive range of microscopy hardware, along with comprehensive rendering and analysis functionality. Modular architecture for best price/performance package on the market.

Third party software compatibility

Drivers are available for a variety of third party imaging packages. See Andor web site for detail: andor.com/software

For SRRF-Stream

The iXon must be operated either through MicroManager (Open Imaging) open source microscopy software platform, or through the Andor SDK, if SRRF-Stream functionality is to be accessed.

Product Drawings

Dimensions in mm [inches]

iXon Ultra 888

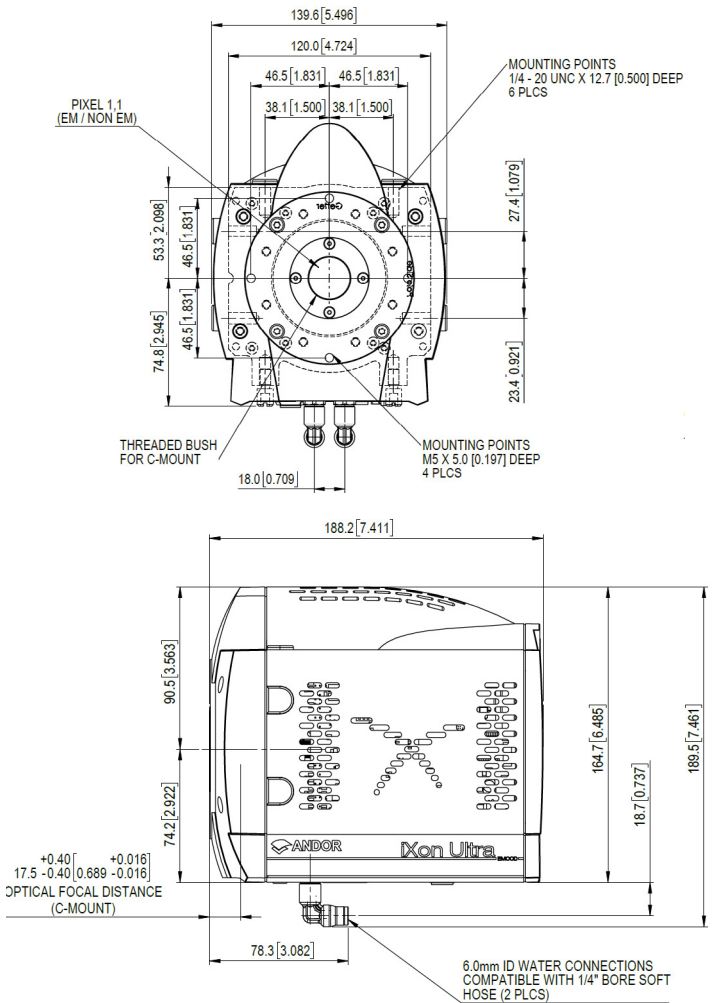

iXon Ultra 897

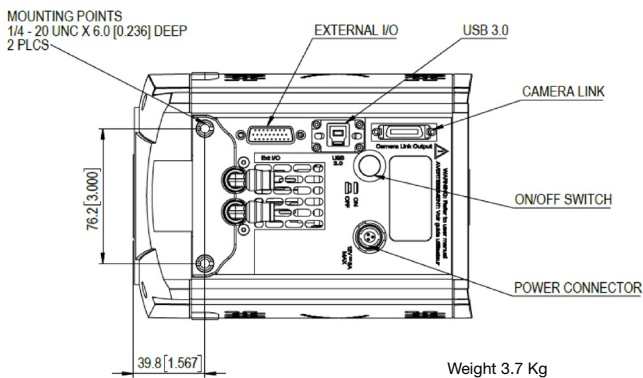
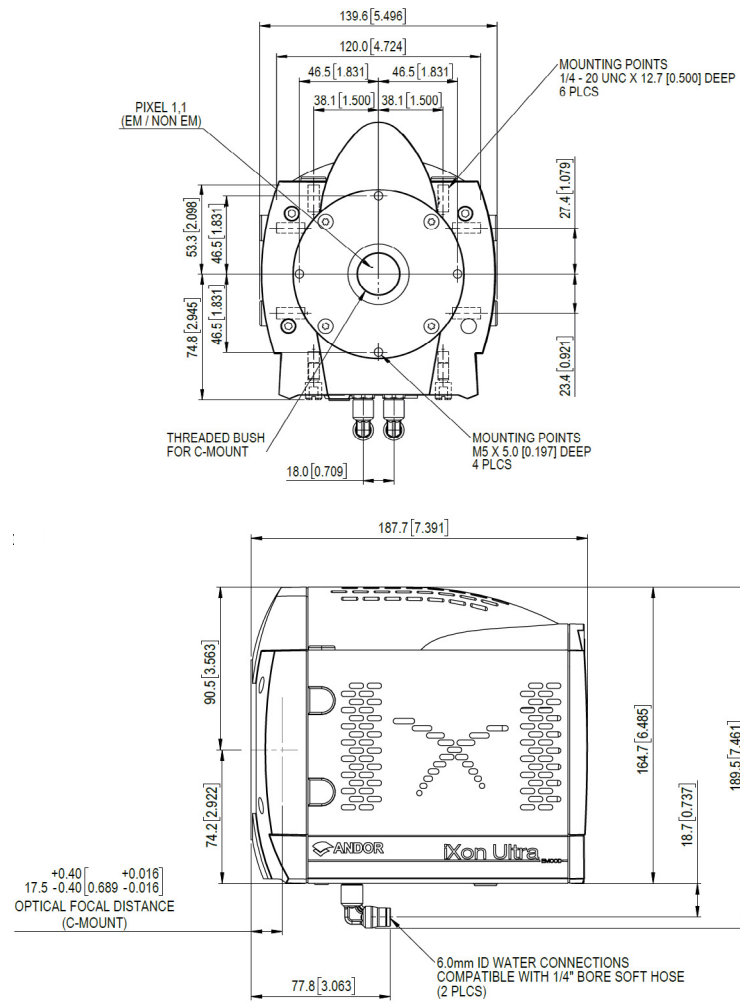

Ultra 888 Power Requirements

- Power Input: +12 VDC ± 5% @ 8 A
- Power Consumption: 96 W max
- Ripple and noise: 120 mV max (peak-peak 0 - 20 MHz)
- External Power Supply: 100 - 240 VAC 50/60 Hz

Logic: Connector type: 26 way D Type with 8 programmable digital inputs or outputs for control and sensing of up to 8 external devices,
Minimum cable clearance required: 90 mm, **Weight:** 3.7 kg [8 lb 3 oz] approx.

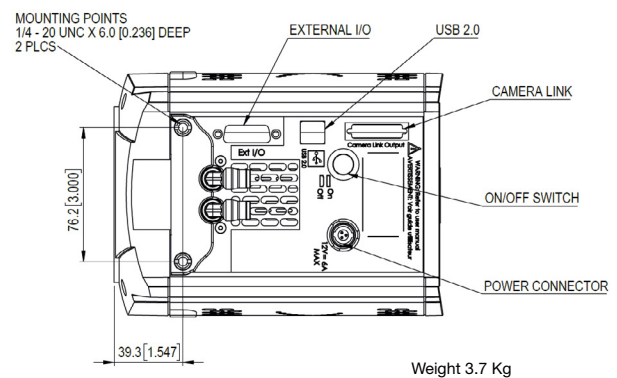

Ultra 897 Power Requirements

- Power Input: +12 VDC ± 5% @ 6 A
- Power Consumption: 72 W max
- Ripple and noise: 120 mV max (peak-peak 0 - 20 MHz)
- External Power Supply: 100 - 240 VAC 50/60 Hz

ORDER TODAY



Need more information? At Andor we are committed to finding the correct solution for you. With a dedicated team of technical advisors, we are able to offer you one-to-one guidance and technical support on all Andor products. For a full listing of our local sales offices, please see: andor.com/contact

Our regional headquarters are:

Europe

Belfast, Northern Ireland
Phone +44 (28) 9023 7126
Fax +44 (28) 9031 0792

Japan

Tokyo
Phone +81 (3) 6732 8968
Fax +81 (3) 6732 8939

North America

Concord, MA, USA
Phone +1 (860) 290 9211
Fax +1 (860) 290 9566

China

Beijing
Phone +86 (10) 5884 7900
Fax +86 (10) 5884 7901

Items shipped with your iXon Ultra 888:

- 1x Andor ACZ-03463: 2m Multi I/O timing cable, offering Fire, External Trigger, Shutter and Arm
- 1x 3m USB 3.0 cable Type A to Type B
- PCIe USB 3.0 Card Adapter (2-Port)^{*12}
- 1x Power supply unit with mains cable
- 1x Quick Start guide
- 1x CD containing Andor user manuals
- 1x SRRF-Stream Quick Start guide (if applicable)

Items shipped with your iXon Ultra 897:

- 1x Andor ACZ-03463: 2 m Multi I/O timing cable, offering Fire, External Trigger, Shutter and Arm
- 1x 3m USB 2.0 cable Type A to Type B
- 1x Power supply unit with mains cable
- 1x Quick Start guide
- 1x CD containing Andor user manuals
- 1x SRRF-Stream Quick Start guide (if applicable)

Footnotes: Specifications are subject to change without notice

1. Assembled in a state-of-the-art cleanroom facility, Andor's UltraVac™ vacuum process combines a permanent hermetic vacuum seal (no o-rings), with a stringent protocol to minimize outgassing, including use of proprietary materials.
2. Figures are typical unless otherwise stated.
3. At 30 MHz overclocked pixel readout rate, thermal dissipation from the sensor is higher since a greater proportion of time is spent vertical shifting, and it is necessary to set a higher sensor cooling temperature at this rate. Furthermore, stable cooling performance will depend on other variables such as vertical clock speed, Region of Interest size (Standard or Crop Mode) and ambient temp. As such, user testing is advised to determine the stable sensor cooling temperature for selected conditions. Status of temperature stability is apparent through the acquisition software.
4. The dark current measurement is averaged over the sensor area excluding any regions of blemishes.
5. Using Electron Multiplication the iXon is capable of detecting single photons, therefore the true camera detection limit is set by the number of 'dark' background events. These events consist of both residual thermally generated electrons and Clock Induced Charge (CIC) electrons (also referred to as Spurious Noise), each appearing as random single spikes above the read noise floor.
A thresholding scheme is employed to count these single electron events and is quoted as a probability of an event per pixel. Acquisition conditions are full resolution and max frame rate (30 MHz readout; frame-transfer mode; 1.1 μs vertical clock speed; x 1000 EM gain; 10 ms exposure; -95°C).
6. The EM register on CCD201 sensors has a linear response up to ~400,000 electrons and a full well depth of ~730,000 electrons.
7. Readout noise is for the entire system. It is a combination of sensor readout noise and A/D noise. Measurement is for Single Pixel readout with the sensor at a temperature of -75°C and minimum exposure time under dark conditions. Under Electron Multiplying conditions, the effective system readout noise is reduced to sub 1 e⁻ levels.
8. Linearity is measured from a plot of counts vs. exposure time under constant photon flux up to the saturation point of the system.
9. All measurements are made at 30 MHz pixel readout speed with 0.6 μs vertical clock speed. It also assumes internal trigger mode of operation. Standard and Crop Mode frame rates shown are for 'Corner Tethered' ROIs, with 'Optically Centred' ROI frame rates shown within brackets.
10. All measurements are made at 17 MHz pixel readout speed with 0.3 μs vertical clock speed. It also assumes internal trigger mode of operation. Standard and Crop Mode frame rates shown are for 'Corner Tethered' ROIs, with 'Optically Centred' ROI frame rates shown within brackets.
11. Quantum efficiency of the sensor at 25°C, as supplied by the sensor manufacturer.
12. iXon Ultra 888 should work with any modern USB 3.0 enabled PC/laptop, as every USB 3.0 port should have its own host controller. iXon Ultra 888 also ships with a USB 3.0 PCI card as a means to add a USB 3.0 port to an older PC, or as a diagnostic aid to interoperability issues.

Recommended Computer Requirements:

- 3.0 GHz single core or 2.6 GHz multi core processor
- 2 GB RAM
- 100 MB free disc space to install software (at least 1 GB recommended for data spooling)
- USB 3.0 Super Speed Host Controller capable of a sustained rate of 60MB/s for iXon Ultra 888
- USB 2.0 High Speed Host Controller capable of sustained rate of 40MB/s for iXon Ultra 897
- Solid-state drive (SSD) capable of a minimum sustained write speed of 100MB/S for spooling data
- Windows (7, 8, 8.1 and 10) or Linux
- SRRF-Stream - If selected, the PC requires an NVidia GPU card. See page 10 for further details.

Operating & Storage Conditions

- Operating Temperature: 0°C to 30°C ambient
- Relative Humidity: < 70% (non-condensing)
- Storage Temperature: -25°C to 50°C

Power Requirements

- Please refer to page 11

